



Dynalite Leading Edge Dimmers

DLE1210GL

12 channel Leading Edge dimmer with a maximum load per channel of 10 A.

The Philips Dynalite DLE1210GL is a 12 channel leading edge dimmer controller, with a maximum load per channel of 10 A and total device load of 75 A. - It is suitable for use with incandescent, neon and selected fluorescent light sources, as well as iron core and leading edge dimmable electronic transformers. - Large load capability DMX512 compatibility Interference suppression Naturally ventilated Soft start and voltage regulation technologies Diagnostic functionality User controls Option available

Product data

General Information	
CE mark	CE mark
Remarks	Please download the Lighting - Product Data Sheet for more information and ordering options
EU RoHS compliant	Yes
Application Conditions	
Ambient temperature range	0 to +40 °C
Product Data	
Full product code	871016350568800

Order product name	DLE1210GL
EAN/UPC – product	8710163505688
Order code	913703014009
SAP numerator – quantity per pack	1
Numerator – packs per outer box	1
SAP material	913703014009
SAP net weight (piece)	16.000 kg

Dynalite Leading Edge Dimmers

Dimensional drawing

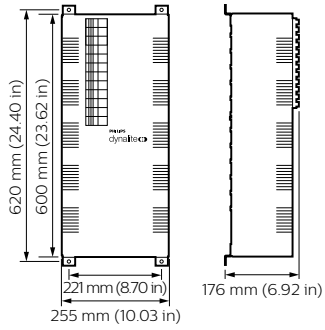

Dynalite Leading Edge Dimmers

