

PrimaVision Compact for CDM

HID-PV C 35 /S CDM 220-240V 50/60Hz NG

High-quality, compact and lightweight HID electronic gear for optimal and reliable performance of 20, 35, 50 and 70 W CDM lamps

Product data

General Information	
Number of Lamps	1 piece/unit
Operating and Electrical	
Input Voltage	220 to 240 V
Line Frequency	50 to 60 Hz
Input Frequency	50 to 60 Hz
Inrush Current Width	0.25 ms
Inrush Current Peak (Max)	26 A
Number of Products on MCB (16A Type B) (Nom)	24
Wiring	
Cable Length From Device to Lamp	1.5 m
Connector Type	Insert
Temperature	
Ambient temperature range	-20 °C to 55 °C
T-Case Lifetime (Nom)	80 °C
T-Case Maximum (Max)	80 °C

Mechanical and Housing	
Housing	/S
Approval and Application	
Safety Standard	EN 61347-2-12
Environmental Standard	ISO 14001
Approval Marks	CE marking ENEC certificate
Product Data	
Full product code	872790085962100
Order product name	HID-PV C 35 /S CDM 220-240V 50/60Hz NG
Order code	913700652766
Numerator - Quantity Per Pack	1
Numerator - Packs per outer box	12
Material number (12NC)	913700652766
Full product name	HID-PV C 35 /S CDM 220-240V 50/60Hz NG
EAN/UPC - Case	8727900859621

PrimaVision Compact for CDM

Dimensional drawing

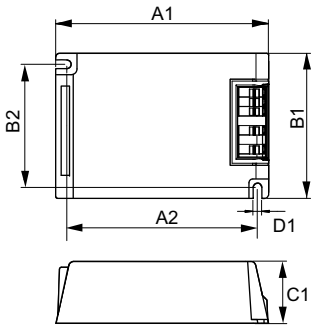

Product	D1	C1	A1	A2	B1	B2
HID-PV C 35 /S CDM 220-240V 50/60Hz NG	4.9 mm	32.2 mm	109.6 mm	98.5 mm	74.4 mm	63.7 mm

