



LuxSpace G4

DN594B LED40/830 PSU C D200 WH MB GC

Reflector

LuxSpace Gen4 is the a new LED downlight range combining light comfort and leading performance with luxury appearance

Product data

General Information	
Lamp colour code	830 warm white
Light source replaceable	No
Number of gear units	1 unit
Driver/power unit/transformer	PSU-E [Power supply unit external (PSU)]
Driver included	Yes
Optic type	Faceted reflector with beam angle 30°
Optical cover/lens type	Reflector
Control interface	-
Connection	PIP2 [Push-in connector with 2 poles and pull relief]
Protection class IEC	Safety class II (II)
Glow-wire test	650/30 [Temperature 650 °C, duration 30 s]
Flammability mark	F [For mounting on normally flammable surfaces]
CE mark	CE mark
Warranty period	3 years
Constant light output	No
Number of products on MCB (16 A type B)	32
EU RoHS compliant	Yes
Light source engine type	LED

Operating and Electrical	
Input Voltage	220 to 240 V
Input frequency	50 or 60 Hz
Inrush current	14.5 A
Inrush time	0.22 ms
Power factor (min.)	0.9

Controls and Dimming	
Dimmable	No

Mechanical and Housing	
Housing material	Aluminum die-cast
Reflector material	Polycarbonate aluminum coated
Optic material	Polycarbonate
Optical cover/lens material	Polycarbonate
Fixation material	Steel
Optical cover/lens finish	Textured
Overall length	0 mm
Overall width	0 mm
Overall height	130 mm
Overall diameter	212 mm

LuxSpace G4

Colour	White and black
--------	-----------------

Approval and Application

Ingress protection code	IP20 [Finger-protected]
Mech. impact protection code	IK03 [0.3 J]

Initial Performance (IEC Compliant)

Initial luminous flux (system flux)	4100 lm
Luminous flux tolerance	+/-10%
Initial LED luminaire efficacy	103 lm/W
Lamp colour temperature	3000 K
Colour Rendering Index	>80
Initial input power	39.7 W
Power consumption tolerance	+/-10%

Over Time Performance (IEC Compliant)

Median useful life L70B50	50000 h
Median useful life L80B50	50000 h

Median useful life L90B50	21000 h
---------------------------	---------

Application Conditions

Ambient temperature range	-20 to +40 °C
Maximum dimming level	Not applicable

Product Data

Full product code	911401547141
Order product name	DN594B LED40/830 PSU C D200 WH MB GC
Order code	911401547141
SAP numerator – quantity per pack	1
Numerator – packs per outer box	1
SAP material	911401547141
SAP net weight (piece)	1.399 kg



Dimensional drawing

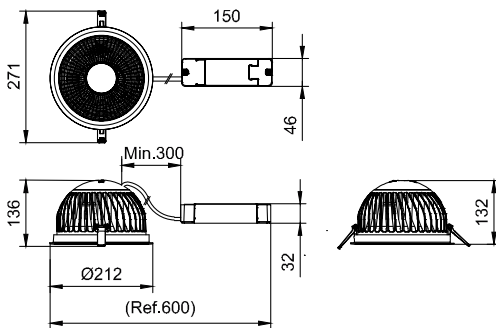

DN58XB/DN59XB

